



## (Abreviaturas de materiales)

**PP:** Polipropileno - **PU:** Poliuretano - **PVC:** Policloruro de vinilo  
**TPR:** Elastómero termoplástico - **PET:** Tereftalato de polietileno

## (Iconografía & unidades de medidas)

	diámetro de rueda		altura de rueda		altura de rueda
	ancho de rueda		altura de rueda		diámetro externo
	ancho de rueda		altura de rueda	A - $\varnothing$ mm	
	ancho de rueda		altura de rueda		diám. externo de encastre
	ancho de rueda		altura de rueda	B - $\varnothing$ mm	
	ancho de rueda		altura de rueda		diámetro interno
	ancho de rueda		altura de rueda	C - $\varnothing$ mm	
	ancho de rueda		ancho de rueda		diámetro interno
	altura de rueda		ancho de rueda		altura de encastre
	altura de rueda		ancho de rueda		diámetro externo
	altura de rueda		ancho de rueda		profundidad de encastre
	altura de rueda		ancho de rueda		ancho de rulemán
	altura de rueda		ancho de rueda		diámetro de perno
	altura de rueda		ancho de rueda		diámetro de bulón
	dimensiones de base		ancho de rueda		diámetro de platina
	tamaño de orificio		ancho con buje		diámetro de rosca
	capacidad de carga		ancho con buje		ancho de encastre
	Bulto cerrado		diámetro de bulón		diámetro interno
	diámetro externo de buje		diámetro de agujero		diámetro de eje
	largo de buje		ancho con soporte		altura de horquilla
	altura de perno		ancho con soporte		altura de horquilla
	altura de perno		ancho de encastre		espesor horquilla
	diámetro de perno		ancho de encastre		
			ángulo de canal		continúa (familia)

CATÁLOGO 2020 - 2021 | WWW.OXEN.COM.AR

## (Unidades de medidas)

**m:** metros - **mm:** milímetros - **kg:** kilogramos - **"**: pulgadas - **°c:** grados centígrados - **L:** litros - **Tn:** toneladas - **lbs:** libras

\*La unidad de medida general utilizada es el "mm" (para medidas sin especificación).





## ÍNDICE

### **Ruedas con horquillas estampadas. (Pág. 04 a 11)**

Ruedas de chapa y goma con rodillo | Ruedas de PP y banda de PVC con rulemán  
Ruedas PP blanca eje con buje | Ruedas PP blanca horquilla acero inox. 304 eje con buje  
Ruedas PU / PP con un rulemán | Ruedas de goma elástica azul con rodillo | Ruedas PP eje con tornillo  
Ruedas PU naranja con rodillo | Ruedas TPR para changó de super con un rulemán | Ruedas TPR con un rulemán  
Ruedas para alta temperatura con buje

### **Ruedas para muebles. (Pág. 12 a 20)**

Ruedas PVC / PP con buje | Ruedas TPR / PP con un rulemán | Ruedas TPR / PP con buje | Ruedas Twin  
Ruedas mini para gran peso con 2 rulemanes | Ruedas PVC transparentes horquillas cromadas con tornillo  
Ruedas de Nylon Max | Ruedas hospitalarias / Horquilla de Nylon con rulemán  
Ruedas PP / Nylon natural | Ruedas bicolor | Ruedas de goma negra | Ruedas PP simples | Ruedas PP dobles

### **Ruedas industriales con horquillas especiales. (Pág. 21 a 26)**

Ruedas TPR / PP con dos rulemanes 6204 | Ruedas PU / PP con dos rulemanes 6204 | Ruedas PP blanca con dos rulemanes 6203  
Ruedas PP blanca con dos rulemanes / bujes de Nylon | Ruedas de fundición y PU rojo con 2 rulemanes  
Ruedas PP blanca con dos rulemanes / bujes de Nylon | Rodillos para transpallets con dos rulemanes 6204 zz  
Ruedas de fundición y PU rojo con dos rulemanes 6203 | Rodillos para transpallets con dos rulemanes 6204 zz  
Ruedas de fundición y goma con rodillo | Ruedas para andamios con rodillo y freno | Ruedas para contenedores con rodillo

### **Ruedas solas. (Pág. 27 a 33)**

Ruedas de goma vulcanizada | Ruedas para carretillas y hormigoneras | Ruedas cespederas plásticas  
Ruedas de chapa y goma con buje de Nylon | Ruedas PP negro | Ruedas para changuitos de compras  
Ruedas cochecito para bebé | Ruedas para patines y roller | Ruedas de acero para portón  
Estabilizadores y rodillos de Nylon para portón | Ruedas de Nylon para portón

### **Ruedas neumáticas. (Pág. 34 a 38)**

Ruedas neumáticas llanta PP gris | Ruedas semineumáticas PU llanta PP gris  
Ruedas semineumáticas PU llanta PP negra | Ruedas semineumáticas PU llanta PP gris  
Ruedas para sillas de ruedas con rulemán 608 zz | Ruedas neumáticas llanta de chapa

### **Accesorios. (Pág. 39 a 41)**

Cubiertas y cámaras | Bujes y rulemanes para ruedas | Horquillas de acero galvanizado

### **Transpallets - Carros (Pág. 42 a 45)**

Apiladores manuales | Transpallets | Carros paqueteros plataformas  
Carros paqueteros 2 ruedas | Carritos plegables | Carretilla batea plástica





**· Ruedas de chapa y goma - con rodillo**



**Base giratoria**

Código	∅					kg	
9595	75	21	95	75 x 60	8 x 12	50	50
9600	85	25	110	102 x 84	9 x 13	60	40
9596	100	26	123	102 x 84	9 x 13	70	38
9597	125	29	147	102 x 84	9 x 13	100	28
9598	160	40	185	135 x 105	11 x 16	120	10
9599	200	50	230	135 x 105	11 x 16	180	6

**Base giratoria con freno**

Código	∅					kg	
19290	75	21	95	75 x 60	8 x 12	50	50
19289	85	25	110	102 x 84	9 x 13	60	48
19291	100	26	123	102 x 84	9 x 13	70	32
19292	125	29	147	102 x 84	9 x 13	100	24
19293	160	40	185	135 x 105	11 x 16	120	8
19294	200	50	230	135 x 105	11 x 16	180	6

**Base fija**

Código	∅					kg	
9590	75	21	95	75 x 60	8 x 12	50	60
9603	85	25	105	102 x 84	9 x 13	60	40
9591	100	26	123	102 x 84	9 x 13	70	38
9592	125	29	147	102 x 84	9 x 13	100	28
9593	160	40	185	135 x 105	11 x 16	120	20
9594	200	50	230	135 x 105	11 x 16	180	6

**Base con agujero**

Código	∅				kg	
19271	75	21	95	10.5	50	60
19272	100	26	123	13	70	24
19273	125	29	147	13	100	28
19274	160	40	185	13	120	10

**Base con agujero y freno**

Código	∅				kg	
19276	75	21	95	10.5	50	60
19277	100	26	123	13	70	32
19278	125	29	147	13	100	24
19279	160	40	185	13	120	8





**· Ruedas de chapa y goma - con rodillo**



**Rueda sola**

Código	∅				kg	
19321	75	21	12.5	30	50	100
19327	85	25	12.5	30	60	100
19322	100	26	13	40	70	80
19323	125	29	15	40	100	48
19324	160	40	20	55	120	10
19325	200	50	20	56	185	10



**· Ruedas de PP y banda de PVC - con rulemán**



**Base giratoria**

Código	∅					kg	
19871	75	31	94	81 x 67	8 x 13	70	60
19872	100	31	127	98 x 81	8.5 x 13.5	80	38
19873	125	31	155	98 x 81	8.5 x 13.5	90	28



**Base giratoria con freno**

Código	∅					kg	
19874	75	31	94	81 x 67	8 x 13	70	60
19875	100	31	127	98 x 81	8.5 x 13.5	80	32
19876	125	31	157	98 x 81	8.5 x 13.5	90	24



**Base fija**

Código	∅					kg	
19877	75	31	94	81 x 70	8 x 13	70	60
19878	100	31	127	100 x 82	8.5 x 13.5	80	38
19879	125	31	157	100 x 82	8.5 x 13.5	90	28



**Rueda sola**

Código	∅				kg	
19881	75	31	10	35	70	1
19882	100	31	10	41	80	1
19883	125	31	13	41	90	1





**· Ruedas PP blanca - eje con buje**



**Base giratoria**

Código	∅					kg	
19174	75	25	94	84 x 72	8 x 12	50	60
19175	80	30	110	100 x 80	9 x 13	120	30
19176	100	32	128	100 x 80	9 x 13	150	24
19177	125	29	152	102 x 84	9 x 13	100	28
19178	152	40	189	140 x 110	11 x 13	200	9

**Base giratoria con freno**

Código	∅					kg	
19229	75	25	94	84 x 72	8 x 12	50	60
19230	80	30	110	100 x 80	9 x 13	120	30
19231	100	32	128	100 x 80	9 x 13	150	24
19232	125	29	152	102 x 84	9 x 13	100	24
19233	152	40	189	140 x 110	11 x 13	200	8

**Base fija**

Código	∅					kg	
19169	75	25	94	84 x 72	8 x 12	50	60
19170	80	30	110	100 x 80	9 x 13	120	30
19171	100	32	128	100 x 80	9 x 13	150	24
19172	125	29	150	102 x 84	9 x 13	100	28
19173	152	40	189	140 x 110	11 x 13	200	8

**Base con agujero**

Código	∅				kg	
19235	75	25	92	10.5	50	60
19236	100	29	120	13	70	38
19237	125	29	150	13	100	28

**Base con agujero y freno**

Código	∅				kg	
19240	75	25	92	10.5	50	60
19241	100	29	120	13	70	32
19242	125	29	150	13	100	24

**Rueda sola**

Código	∅				kg	
20072	73	28	8	30	50	180
19245	100	29	10	40	60	150
19246	125	29	10	40	70	80





**· Ruedas PP blanca horquilla acero inox. 304 - eje c/ buje**



**Base giratoria**

Código	∅					kg	
18807	75	26	97	84 x 72	8.2 x 11	70	60
18808	100	32	128	100 x 80	9 x 13	120	24
18809	125	29	153	102 x 84	9 x 14	100	28

**Base giratoria con freno**

Código	∅					kg	
18814	75	26	97	84 x 72	8.2 x 11	70	48
18815	100	32	128	100 x 80	9 x 13	120	24
18816	125	29	153	102 x 84	9 x 14	100	24

**Base fija**

Código	∅					kg	
18801	75	26	97	84 x 72	8.2 x 11	70	60
18802	100	32	128	100 x 80	9 x 13	120	24
18803	125	29	153	102 x 84	9 x 14	100	28



\* Tornillo y tuerca de acero inoxidable

**· Ruedas PU/PP - con un rulemán**



**Base giratoria**

Código	∅					kg	
19851	75	26	97	84 x 72	8 x 11	60	60
19852	100	29	130	102 x 84	9 x 14	120	38
19853	125	29	155	102 x 84	9 x 14	150	28

**Base giratoria con freno**

Código	∅					kg	
19856	75	26	97	84 x 72	8 x 11	60	60
19857	100	29	130	102 x 84	9 x 14	120	38
19858	125	29	155	102 x 84	9 x 14	150	28

**Base fija**

Código	∅					kg	
19846	75	26	97	84 x 72	8 x 11	60	60
19847	100	29	130	102 x 84	9 x 14	120	38
19848	125	29	155	102 x 84	9 x 14	150	28

**Rueda sola**

Código	∅				kg	
19860	75	26	8	32	60	180
19861	100	29	8	42	120	80
19862	125	29	8	42	150	48





## · Ruedas de goma elástica azul - con rodillo



### Base giratoria

Código	∅					kg	
19605	75	27	97	72 x 84	8 x 11	80	60
19606	100	32	122	102 x 84	9 x 14	100	30
19607	100	27	130	100 x 80	11 x 16	100	30
19608	125	27	156	113 x 100	12 x 16	120	32

### Base giratoria con freno

Código	∅					kg	
19610	75	27	97	72 x 84	8 x 11	80	60
19611	100	32	122	102 x 84	9 x 14	100	24

### Base fija

Código	∅					kg	
19600	75	27	97	72 x 84	8 x 11	80	60
19601	100	32	122	102 x 84	9 x 14	100	30
19602	100	27	128	100 x 80	11 x 16	100	30
19603	125	27	163	113 x 100	12 x 16	120	32

### Rueda sola

Código	∅				kg	
19630	75	27	9	31	80	180
19631	100	32	9	36	100	180

## · Ruedas PP - eje con tornillo



### Rueda con horq. p/ piso en desnivel

Código	∅					kg	
19248	100	29	130	150	60	30	

¡Se adapta al terreno!

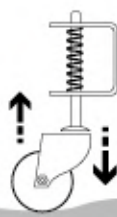

IDEAL PARA PORTÓN

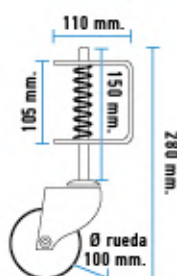





**· Ruedas PU naranja - con rodillo**



**Base giratoria**

Código	∅					kg	
19830	75	32	105	95 x 65	8 x 12	100	40
19831	100	32	131	95 x 65	8 x 12	130	36
19832	125	32	154	95 x 65	8 x 12	150	30

**Base giratoria con freno**

Código	∅					kg	
19833	75	32	105	95 x 65	8 x 12	100	30
19834	100	32	131	95 x 65	8 x 12	130	40
19835	125	32	154	95 x 65	8 x 12	150	24

**Base fija**

Código	∅					kg	
19836	75	32	105	95 x 65	8 x 12	100	36
19837	100	32	131	95 x 65	8 x 12	130	40
19838	125	32	154	95 x 65	8 x 12	150	30

**Rueda sola**

Código	∅				kg	
19839	75	32	9	42	100	40
19840	100	32	9	42	130	36
19841	125	32	9	42	150	30



**· Ruedas TPR para chango de super - con un rulmán**



**Rueda con base**

Código	∅				Base	kg	
19671	100	29	135	13	Giratoria	100	38
19672	125	29	153	13	Giratoria	120	20
19670	125	29	153	13	Fija	120	20
22318	125	27	153	12.5	Giratoria	100	24

**Rueda sola**

Código	∅				kg	
19675	100	29	8.5	40	100	100
19676	125	29	8.5	43	120	48
19678	125	27	8.5	43	100	50





**· Ruedas TPR - con un rulemán**



**Base giratoria**

Código	∅					kg	
22305	75	26	97	84 x 72	8 x 11	60	60
22306	100	32	128	100 x 80	9 x 13	120	24
22307	125	29	155	102 x 84	9 x 14	120	28

**Base giratoria con freno**

Código	∅					kg	
22310	75	26	97	84 x 72	8 x 11	60	60
22311	100	32	128	100 x 80	9 x 13	120	24
22312	125	29	155	102 x 84	9 x 14	120	24

**Base fija**

Código	∅					kg	
22300	75	26	97	84 x 72	8 x 11	60	60
22301	100	29	130	102 x 84	9 x 14	100	38
22302	125	29	155	102 x 84	9 x 14	120	28

**Base con agujero**

Código	∅					kg	
22316	100	29	132	13	59	100	38
22317	125	32	150	12,5	59	170	15

**Base con agujero y freno**

Código	∅					kg	
22321	100	29	132	13	59	100	38
22322	125	32	150	12,5	61	170	15

**Rueda sola**

Código	∅				kg	
22327	75	26	8	32	60	180
22328	100	29	8	42	100	80
22329	125	29	8	42	120	48





**· Ruedas para alta temperatura - con buje**



**Hierro - base giratoria**

Código	∅					kg	
19255	75	30	115	100 x 84	9 x 13	120	1
19256	75	30	94	70 x 58	8 x 11	100	40
19257	100	31	127	100 x 84	9 x 13	120	20

**Hierro - base fija**

Código	∅					kg	
19251	75	30	94	70 x 62	8 x 11	100	40
19252	100	31	127	100 x 84	9 x 13	120	20

**Hierro - ruela sola**

Código	∅				kg	
19253	75	30	8	32	100	1
19258	100	31	12	40	120	40

**Nylon - base giratoria**

Código	∅					kg		
19259	75	32	107	100 x 80	9 x 13	80	1	-
19260	100	35	127	100 x 80	9	90	1	-
19261	100	35	127	100 x 80	9 x 13	100	1	Reforzada
19267	100	35	127	128 x 105	10 x 13	120	1	Grande
19262	100	40	127	100 x 80	9 x 13	120	1	Reforzada
19263	100	40	127	128 x 105	10 x 13	120	1	Grande

**Nylon - rueda sola**

Código	∅				kg	
19264	75	32	13	36	80	1
19265	100	35	13	43	100	1
19266	100	40	13	43	120	1





**· Ruedas PVC / PP - con buje**



**Base giratoria**

Código	∅					kg	
19056	50	18	72	50 x 50	6 x 12	50	100
19058	75	21	104	65 x 65	6 x 12	70	60
19059	100	25	132	75 x 75	8.5 x 15	80	40

**Base giratoria con freno**

Código	∅					kg	
19061	50	18	72	50 x 50	6 x 12	50	100
19063	75	21	104	65 x 65	6 x 12	70	60
19064	100	25	132	75 x 75	8.5 x 15	80	40

**Base fija**

Código	∅					kg	
19051	50	18	68	65 x 50	6 x 12	50	140
19053	75	21	104	100 x 59	6 x 12	70	60
19054	100	25	132	100 x 59	8.5 x 15	80	40

**Base con agujero**

Código	∅				kg	
19066	50	18	70	10.5	50	100
19068	75	21	95	10.5	70	80
19069	100	25	130	13	80	40

**Base con agujero y freno**

Código	∅				kg	
19071	50	18	70	10.5	50	100
19073	75	21	100	10.5	70	80
19074	100	25	130	13	80	40

**Rueda sola**

Código	∅				kg	
19091	50	18	8	22	50	200
19093	75	21	10	25	70	200
19094	100	25	12	32	80	100

**· Ruedas TPR / PP - con un rulemán**



**Base giratoria**

Código	∅					kg	
19025	50	20	70	50 x 50	6 x 12	50	130
19026	75	25	100	60 x 60	6 x 12	70	60
19027	100	27	134	75 x 75	8.5 x 15	80	30





**· Ruedas TPR/PP - con un rulemán**



**Base giratoria con freno**

Código	∅					kg	
19029	50	20	70	50 x 50	6 x 12	50	130
19030	75	25	100	60 x 60	6 x 12	70	50
19031	100	27	134	75 x 75	8.5 x 15	80	30



**· Ruedas TPR/PP - con buje**



**Base giratoria**

Código	∅					kg	
18864	50	20	70	50 x 50	6 x 12	50	130
18865	75	25	100	60 x 60	6 x 12	70	60
18866	100	27	134	75 x 75	8.5 x 15	80	30



**Base giratoria con freno**

Código	∅					kg	
18868	50	20	70	50 x 50	6 x 12	50	100
18869	75	25	100	60 x 60	6 x 12	70	50
18870	100	27	134	75 x 75	8.5 x 15	80	30



**Base fija**

Código	∅					kg	
18860	50	20	70	50 x 50	6 x 12	50	130
18861	75	25	100	60 x 60	6 x 12	70	60
18862	100	27	134	75 x 75	8.5 x 15	80	30



**Base con agujero**

Código	∅				kg	
18872	50	20	70	10.5	50	150
18873	75	25	100	10.5	70	75
18874	100	27	134	12.5	80	30



**Base con agujero y freno**

Código	∅				kg	
18876	50	20	70	10.5	50	100
18877	75	25	100	10.5	70	50
18878	100	27	134	12.5	80	30



**Rueda sola**

Código	∅				kg	
18880	50	20	8	22	50	400
18881	75	25	8	27	70	150
18882	100	27	12	32	80	60





**· Ruedas Twin**

**Nylon - base giratoria**

Código	Ø					Base	kg	
19750	36	16+16	53	60 x 60	6 x 13	Giratoria	60	100
19751	50	18+18	71	60 x 60	6 x 13	Giratoria	100	50
19754	50	18+18	71	60 x 60	6 x 13	Gir. c/ freno	100	50



**Nylon - base con agujero**

Código	Ø				Base	kg	
19760	36	16+16	53	10.5	Agujero	60	100
19761	50	18+18	71	10.5	Agujero	100	50
19764	50	18+18	71	10.5	Aguj. c/ freno	100	50



**PP negro - base giratoria**

Código	Ø					Base	kg	
19766	50	17+17	70	60 x 60	6 x 13	Giratoria	80	80
19767	50	17+17	70	60 x 60	6 x 13	Gir. c/ freno	80	90



**PP negro - base con agujero**

Código	Ø				Base	kg	
19768	50	17+17	70	10.5	Agujero	80	80
19769	50	17+17	70	10.5	Aguj. c/ freno	80	90



**Aro PP / banda TPR - base giratoria**

Código	Ø					Base	kg	
19755	50	18+18	70	60 x 60	6 x 13	Giratoria	70	70
19771	75	25+25	102	77 x 67	8.5 x 16	Giratoria	100	48
19756	50	18+18	70	60 x 60	6 x 13	Gir. c/ freno	70	70
19772	75	25+25	102	77 x 67	8.5 x 16	Gir. c/ freno	100	32



**Aro PP / banda TPR - base c/ agujero**

Código	Ø				Base	kg	
19757	50	18+18	71	10.5	Agujero	70	90
19774	75	25+25	98	12.5	Agujero	100	48
19758	50	18+18	71	10.5	Aguj. c/ freno	70	70
19775	75	25+25	98	12.5	Aguj. c/ freno	100	32





**·Ruedas mini para gran peso - con dos rulemanes**

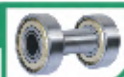

**Rueda piano PUrojo**

Código	Ø				Base	kg	
19776	35	27	65	60 x 48	6.3	Giratoria	120
19777	35	27	65	60 x 48	6.3	Gir. c/ freno	120

**Ruedas PUnaranja base negra**

Código	Ø				Base	kg	
19990	40	23	62	61 x 44	6	Giratoria	35
19991	50	25	74	70 x 52	8	Giratoria	45

Código	Ø				Base	kg	
19993	40	23	62	61 x 44	6	Gir. c/ freno	35
19994	50	25	74	70 x 52	8	Gir. c/ freno	45

Código	Ø				Base	kg	
19996	40	23	62	61 x 44	6	fija	35
19997	50	25	74	70 x 52	8	fija	45

**Rueda Nylon negro base negra**

Código	Ø				Base	kg	
19737	40	26	58	61 x 48	6	Giratoria	70
19778	50	30	70	72 x 54	7	Giratoria	120
19738	40	26	58	61 x 48	6	Gir. c/ freno	70
19779	50	30	70	72 x 54	7	Gir. c/ freno	120
19739	40	26	58	61 x 48	6	Fija	70
19780	50	30	70	72 x 54	7	Fija	120

**·Ruedas PVC transparentes - con tornillo**



**Rueda horquilla cromada**

Código	Ø				Base	kg	
19125	35	19	48	42 x 42	4	Giratoria	20
19126	50	20	63	42 x 42	4	Giratoria	30
19127	75	23	97	60 x 60	6.5 x 8.5	Giratoria	40
19128	35	19	48	42 x 42	4	Con freno	20
19129	50	20	63	42 x 42	4	Con freno	30
19130	75	23	97	60 x 60	6.5 x 8.5	Con freno	40





**· Ruedas de Nylon Max**



**Base giratoria**

Código	Ø				Eje	kg	
18890	50	20	70	50 x 50	6 x 12	buje	50 130
18891	75	23.5	100	60 x 60	6 x 13	buje	90 60
18892	100	30	134	76 x 76	8.5 x 15	rodillo	145 30

**Base giratoria con freno**

Código	Ø				Eje	kg	
18894	50	20	70	50 x 50	6 x 12	buje	50 130
18895	75	23.5	100	60 x 60	6 x 13	buje	90 60
18896	100	30	134	76 x 76	8.5 x 15	rodillo	145 30

**Base fija**

Código	Ø				Eje	kg	
18898	50	20	70	50 x 50	6 x 12	buje	50 100
18899	75	23.5	100	60 x 60	6 x 13	buje	90 50
18900	100	30	134	76 x 76	8.5 x 15	rodillo	145 30

**· Ruedas hospitalarias / Horquilla de Nylon - con rulemán**



**Base giratoria con agujero**

Código	Ø				-	kg	
22319	100	32	135	13	-	70	24
22320	125	32	162	13	-	80	20

**Base girat. c/ agujero y freno**

Código	Ø				-	kg	
22323	100	32	135	13	-	70	20
22324	125	32	162	13	-	80	15

**· Ruedas PP / Nylon natural - eje con bulón**



**Base giratoria**

Código	Ø				-	kg	
19161	38	23	49	61 x 44	6.3	-	40 200
19162	50	25	65	65 x 48	6.3	-	60 120
19163	63	28	81	94 x 70	8.5	-	80 50
19164	75	31	96	104 x 89	9	-	100 30
19165	100	31	127	128 x 101	10.5	-	140 24







**· Ruedas PP / Nylon natural**

**Base fija**

Código	∅					-	kg	
19178	38	23	50	61 x 38	6.3	-	40	200
19179	50	25	65	66 x 42	6.3	-	60	120
19180	63	28	81	98 x 55	8.5	-	80	50
19181	75	31	96	103 x 60	8	-	100	30
19182	100	32	125	130 x 69	10.5	-	140	24



**Rueda sola**

Código	∅				kg	
19393	38	23	6	25	40	300
19394	50	25	6	27	60	300
19395	65	28	8.5	34	80	200
19396	75	31	13	39	100	100
19397	100	32	13	50	140	50



**· Ruedas bicolor**

**PU gris - Nylon negro dobles**

Código	∅					Descrip.	kg	
9460	50	67	54	-	42 x 42	Base girat.	30	200
9461	50	64	54	15	5/16"	Perno roscado	30	200
9462	50	61	54	15	3/8"	Perno roscado	30	200
9464	50	62	54	15	8 mm	Perno estriado	30	200
9465	50	62	54	21	11 mm	Sillón universal	30	200



**Bicolor mini - base giratoria**

Código	∅					kg	
19106	30	14	40	39 x 38	4	15	600
19107	40	17	49	45 x 38	4	20	300
19108	50	22	64	58 x 47	6	30	150
19109	65	26	83	70 x 58	8	45	80



**Balón - TPR gris / PP negro**

Código	∅				Descrip.	kg		
9444	40	-	52	3/8"	Perno roscado	20	120	
9445	50	-	60	3/8"	Perno roscado	25	120	
9454	40	52	-	-	38 x 38	Base girat.	20	120
9455	50	60	-	-	38 x 38	Base girat.	25	120





**• Ruedas de goma negra**

**Balón**

Código	Ø					Descrip.	kg	
9441	40	-	50	3/8"	-	Con tomillo	20	120
9442	50	-	64	3/8"	-	Con tomillo	25	120
9451	40	51	-	-	38 x 38	Base girat.	20	120
9452	50	60	-	-	38 x 38	Base girat.	25	120



**Base giratoria**

Código	Ø			-			kg	
19190	30	13	37	-	38 x 33	4	15	600
19191	40	17	50	-	47 x 39	5	20	300
19192	50	22	65	-	60 x 50	6	30	150
19193	65	23	82	-	65 x 54	7	35	100



**Rueda con perno roscado 3/8"**

Código	Ø				-		kg	
19121	40	17	50	15	-	3/8"	20	300
19122	50	22	64	15	-	3/8"	30	150
19123	65	25	82	20	-	3/8"	35	150



**• Ruedas PP simples**

**Base giratoria - MOR**

Código	Ø					Color	kg	
20084	40	17	50	49 x 40	4.5	Negra ●	30	200
20085	48	22	65	67 x 50	6	Negra ●	50	50
20086	63	27	85	74 x 61	8.5	Negra ●	60	50
20087	75	28	94	74 x 61	8.5	Negra ●	70	50
18821	100	32	124	98 x 80	8.5	Negra ●	70	20
20094	40	17	50	49 x 40	4.5	Blanca ○	30	200
20095	48	22	65	67 x 50	6	Blanca ○	50	50
20096	63	27	85	74 x 61	8.5	Blanca ○	60	50
20097	75	28	94	74 x 61	8.5	Blanca ○	70	50
19812	100	32	124	98 x 80	8.5	Blanca ○	70	20



**Base fija - MOR**

Código	Ø					Color	kg	
20078	48	22	65	65 x 53	6 x 8	Negra ●	50	100
20090	48	22	65	65 x 53	6 x 8	Blanca ○	50	100





**• Ruedas PP simples**

**Camera - base fija**

Código	Ø				Descrip.	kg	
19099	40	17	47		TPR-PP bicolor	25	300
19098	42	18	-	-	PP sop. ángulo	25	200
19100	42	18	48		PP base fija	25	200
20082	48	22	65		Desplaz. blanca	30	1
20083	48	22	65		Desplaz. negra	30	1



**• Ruedas PP simples**

**Rueda sola - MOR**

Código	Ø				Color	kg	
20069	40	17	5.5	21	Negra ●	30	250
20070	50	22	5.5	23	Negra ●	48	200
20073	63	27	8	31	Negra ●	60	100
20074	73	28	8	31	Negra ●	70	100
18817	100	32	8	36	Negra ●	70	50
20067	40	17	5.5	21	Blanca ○	30	250
20068	50	22	5.5	23	Blanca ○	48	200
20071	63	27	8	31	Blanca ○	60	100
20072	73	28	8	31	Blanca ○	70	100
19802	100	32	8	36	Blanca ○	70	50



**Base con perno roscado 3/8" - MOR**

Código	Ø				Color	kg	
19196	40	17	50	15 3/8"	Negra ●	30	200
19197	50	22	65	15 3/8"	Negra ●	50	100
19184	40	17	50	15 3/8"	Blanca ○	30	200
19185	50	22	65	15 3/8"	Blanca ○	50	100



**Base giratoria - blanca**

Código	Ø					kg	
19111	30	14	37	39 x 33	4	15	600
19112	40	17	54	45 x 40	5	20	300
19113	50	22	64	60 x 48	6	30	120
19114	65	24	80	65 x 54	7	35	100
19115	75	27	91	70 x 58	8.5	50	50



**Base con perno roscado 3/8" - blanca**

Código	Ø					kg	
19117	40	17	54	15 3/8"	20	300	
19118	50	22	65	20 3/8"	30	150	
19119	65	25	84	25 3/8"	35	100	





**· Ruedas PP dobles**

**Base giratoria**

Código	Ø					Descrip.	kg	
9401	40	56	41	38 x 38	5	Giratoria	25	240
9402	50	55	40	38 x 38	5	Giratoria	30	200



**Perno roscado**

Código	Ø					Descrip.	kg	
9407	40	49	40	19/25	1/4"	Perno rosc.	25	240
9409	40	49	40	19	5/16"	Perno rosc.	25	200
9410	50	59	47	20	1/4"	Perno rosc.	30	200
9411	50	59	47	17	5/16"	Perno rosc.	30	200
9412	50	60	47	18	3/8"	Perno rosc.	30	200



**Perno estriado**

Código	Ø					Descrip.	kg	
9413	40	56	41	25	6.5	Perno estria.	25	200
9414	50	60	47	19.5	8.5	Perno estria.	40	200



**Base "U"**

Código	Ø				Descrip.	kg	
9418	40	53	40	16	Negro epoxi	25	240
9419	40	53	40	19	Negro epoxi	25	240
9421	50	64	46	16	Negro epoxi	30	200
9422	50	64	47	19	Negro epoxi	30	200



**Pernos varios**

Código	Ø	Uso	Perno	kg	
9403	40	MDF	Con sombrero	25	240
9415	40	TV	Para madera - 30 mm	25	240
9417	40	TV	Para madera - 47 mm	30	240
9416	50	TV	Para madera - 30 mm	30	200
9424	45	TV	Con capuchón de 12 mm	25	200
9431	45	Lavarropas	Traba con capuchón	25	200
9425	50	Sillón	Nylon univer. 11 mm	40	200





**• Ruedas TPR / PP - con dos rulemanes 6204**



**Base giratoria**

Código	Ø						
20026	100	50	140	115 x 100	11 x 20	160	10
20027	125	50	162	115 x 100	11 x 20	200	10
20028	152	50	190	115 x 100	11 x 20	240	10
20029	200	50	240	115 x 100	11 x 20	300	6



**Base giratoria con freno**

Código	Ø						
20030	100	50	140	115 x 100	11 x 20	160	10
20031	125	50	162	115 x 100	11 x 20	200	10
20032	152	50	190	115 x 100	11 x 20	240	10
20033	200	50	240	115 x 100	11 x 20	300	6



**Base fija**

Código	Ø						
20022	100	50	140	115 x 100	11 x 20	160	10
20023	125	50	162	115 x 100	11 x 20	200	10
20024	152	50	190	115 x 100	11 x 20	240	10
20025	200	50	240	115 x 100	11 x 20	300	6



**Rueda sola**

Código	Ø					
20018	100	50	20	55	160	20
20019	125	50	20	55	200	16
20020	152	50	20	55	240	12
20021	200	50	20	55	300	10



**• CON FRENO DOBLE**



*(En un solo movimiento, frena rueda y horquilla).*



**· Ruedas PU / PP - con dos rulemanes 6204**



**Base giratoria**

Código	∅					kg	
20037	100	50	140	115 x 100	11 x 20	160	10
20038	125	50	162	115 x 100	11 x 20	200	10
20039	152	50	190	115 x 100	11 x 20	240	10
20040	200	50	240	115 x 100	11 x 20	300	6

**Base giratoria con freno**

Código	∅					kg	
20041	100	50	140	115 x 100	11 x 20	160	10
20042	125	50	162	115 x 100	11 x 20	200	10
20043	152	50	190	115 x 100	11 x 20	240	10
20044	200	50	240	115 x 100	11 x 20	300	6

**Base fija**

Código	∅					kg	
20045	100	50	140	115 x 100	11 x 20	160	10
20046	125	50	162	115 x 100	11 x 20	200	10
20047	152	50	190	115 x 100	11 x 20	240	10
20048	200	50	240	115 x 100	11 x 20	300	6

**Rueda sola**

Código	∅				kg	
20050	100	50	20	55	160	20
20051	125	50	20	55	200	16
20052	150	50	20	55	240	12
20053	200	50	20	55	300	10



**· Ruedas PP blanca - con dos rulemanes 6203**



**Base giratoria**

Código	∅					kg	
19406	100	43	137	114 x 100	11 X 20	120	10
19403	125	43	160	114 x 100	11 X 20	180	10
19404	150	44	182	114 x 100	11 X 18	200	10
19405	200	44	232	114 x 100	11 X 18	250	6

**Base giratoria con freno**

Código	∅					kg	
20012	100	43	137	114 x 100	11 X 20	120	10
20013	125	43	160	114 x 100	11 X 20	180	10
20014	150	44	182	114 x 100	11 X 18	200	8
20015	200	44	232	114 x 100	11 X 18	250	5





**· Ruedas PP blanca - con dos rulemanes / bujes de Nylon**

**Base fija**

Código	∅					kg	
19399	100	43	137	114 x 100	11 X 18	120	10
19400	125	43	160	114 x 100	11 X 18	180	10
19401	150	44	182	114 x 100	11 X 18	200	10
19402	200	44	232	114 x 100	11 X 18	250	6



**Rueda sola c/ dos rulemanes**

Código	∅				Rulemán	kg	
29406	100	44	17	48	6203 - ZZ	120	20
29407	125	44	17	48	6203 - ZZ	180	16
29408	150	44	17	48	6203 - ZZ	200	12
29409	200	44	17	48	6203 - ZZ	250	10
19500	200	44	20	50	6204 - ZZ	400	1
19501	200	44	47	50	sin rulemán	400	1



**Rueda sola c/ dos bujes Nylon**

Código	∅				-	kg	
19380	100	44	19	48	-	120	10
19390	125	44	19	48	-	180	6
19414	150	44	19	48	-	200	10
19418	200	44	19	48	-	250	6



**· Rodillos para transpallets - con dos rulemanes 6204 zz**

**Nylon con dos rulemanes**

Código	∅			Rulemán	Descripción	kg	
19523	80	55	20	6204 - ZZ	Rodillo	200	75
19527	80	60	20	6204 - ZZ	Rodillo	250	20
19528	80	70	20	6204 - ZZ	Rodillo	300	20
19524	80	80	20	6204 - ZZ	Rodillo	350	50
19525	80	90	20	6204 - ZZ	Rodillo	400	40
19526	80	100	20	6204 - ZZ	Rodillo	500	30



**Nylon sin rulemán**

Código	∅			-	Descripción	kg	
19530	80	55	47	-	Rodillo	180	1
19531	80	60	47	-	Rodillo	200	1
19532	80	70	47	-	Rodillo	250	1
19533	80	80	47	-	Rodillo	260	1
19534	80	90	47	-	Rodillo	280	1
19535	80	100	47	-	Rodillo	300	1





**· Ruedas de fundición y PU rojo - con dos rulemanes 6203**



**Base giratoria**

Código	∅					kg	
22511	100	50	130	115x100	11 x 20	250	10
22512	125	50	160	115x100	11 x 20	300	10
22513	150	50	190	115x100	11 x 20	350	10
22514	200	50	240	115x100	11 x 20	400	5

**Base giratoria c/ freno y traba**

Código	∅					kg	
22516	100	50	130	115x100	11 x 20	250	10
22517	125	50	160	115x100	11 x 20	300	10
22518	150	50	190	115x100	11 x 20	350	8
22519	200	50	240	115x100	11 x 20	400	5

**Base fija**

Código	∅					kg	
22506	100	50	130	115x100	11 x 20	250	10
22507	125	50	160	115x100	11 x 20	300	10
22508	150	50	190	115x100	11 x 20	350	10
22509	200	50	240	115x100	11 x 20	400	5

**Rueda sola c/ dos rulemanes**

Código	∅				Rulemán	kg	
22501	100	50	17	55	6203 ZZ	250	20
22502	125	50	17	55	6203 ZZ	300	16
22503	150	50	17	55	6203 ZZ	350	12
22504	200	50	17	55	6203 ZZ	400	8
19502	180	50	20	55	Eje despl. Rul. 6204zz p/ zorra hidráulica	480	1

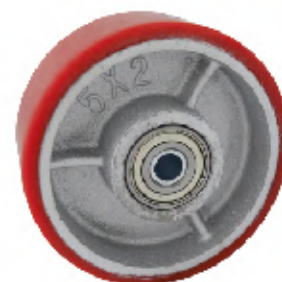

**· Rodillos para transpallets - con dos rulemanes 6204 zz**

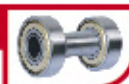

**PU con dos rulemanes**

Código	∅			Rulemán	Descripción	kg	
19503	80	60	20	6204 - ZZ	Rodillo	250	20
19504	80	70	20	6204 - ZZ	Rodillo	350	20
19506	80	90	20	6204 - ZZ	Rodillo	400	20
19507	80	100	20	6204 - ZZ	Rodillo	500	20







**· Ruedas de fundición y goma - con rodillo**



**Base giratoria**

Código	∅					kg	
19428	100	50	140	114 x 100	11 x 20	150	10
19429	125	50	160	114 x 100	11 x 20	180	10
19432	150	50	190	114 x 100	11 x 20	250	10
19433	200	50	237	114 x 100	11 x 20	300	6

**Base giratoria con freno**

Código	∅					kg	
19436	100	50	140	114 x 100	11 x 20	150	10
19437	125	50	160	114 x 100	11 x 20	180	10
19438	150	50	190	114 x 100	11 x 20	250	8
19439	200	50	237	114 x 100	11 x 20	300	5

**Base fija**

Código	∅					kg	
19411	100	50	140	114 x 100	11 x 20	150	10
19413	125	50	160	114 x 100	11 x 20	180	10
19416	150	50	190	114 x 100	11 x 20	250	8
19420	200	50	237	114 x 100	11 x 20	300	5

**Rueda sola**

Código	∅				kg	
19444	100	50	19	63	150	20
19445	125	50	19	63	180	16
19448	160	50	19	63	250	12
19449	200	50	19	63	300	10



**1 - Ruedas con alemite para lubricación.  
2 - Freno para rueda.**



**• Ruedas para andamios - con rodillo y freno**



**Fundición y goma - encastre hembra**

Código	Ø					kg	
19440	160	50	180	115	54 Diám. interno	200	6
19441	200	50	232	100	54 Diám. interno	230	6

\*Horquilla estampada

**Fundición y goma - encastre hembra**

Código	Ø					kg	
19579	160	50	180	100	54 Diám. interno	230	6
19580	200	50	232	100	54 Diám. interno	270	4

\*Horquilla reforzada

**Chapa y goma - encastre hembra**

Código	Ø					kg	
19588	160	40	180	115	54 Diám. interno	150	10
19589	200	50	232	100	54 Diám. interno	200	6

**Chapa y goma - perno macho liso**

Código	Ø					kg	
19442	160	35	180	100	35	230	8
19443	200	35	232	100	35	270	6

**Fundición y goma - perno roscado**

Código	Ø					kg	
19595	150	50	180	400	40	280	6

**• Ruedas para contenedores - con rodillo**



**Base giratoria freno invertido**

Código	Ø				Descrip.	kg	
19720	200	50	230	140 x 110	11 x 13 Chapa/goma	250	6
19728	200	50	230	140 x 110	11 x 13 PP / goma	250	10 (Sin freno)
19730	200	50	230	140 x 110	11 x 13 PP / goma	250	10





**· Ruedas de goma vulcanizada**

**Goma y PP gris sin buje**

Código	∅				kg	
22361	160	45	16	43	100	10
22350	160	45	19	43	100	10
22362	175	45	16	43	120	10
22351	175	45	19	43	120	10
22363	200	45	16	43	130	10
22352	200	45	19	43	130	10

**Goma y PP negro sin buje**

Código	∅				kg	
22380	160	45	19	43	100	10
22381	175	45	19	43	120	10
22382	200	45	19	43	130	10

**Goma y PP gris c/ buje de Nylon**

Código	∅				kg	
22365	250	50	16	52	130	10
22354	250	50	19	52	130	10
22376	300	50	16	52	150	10
22375	300	50	19	52	150	10

**Goma y PP negro c/ buje de Nylon**

Código	∅				kg	
22385	250	52	16	52	130	10
22386	250	52	19	52	130	10
22389	300	57	16	52	150	10
22390	300	57	19	52	150	10

**Goma y PP negro c/ rulemán 6204 - 2 RS 19.2 mm**

Código	∅				kg	
22393	250	50	19.2	52	130	10
22395	300	50	19.2	52	150	10

**Goma negra compacta**

Código	∅			Descripción	kg	
9511	340	60	16.6	Carretilla	100	1
9736	350	70	16.6	Carretilla	130	1
9738	350	70	26	Homigonera	130	1





**· Ruedas para carretillas y hormigoneras**

**PP negro**

Código	Ø			Descripción	kg	
<b>9491</b>	350	50	16	Carretilla / con buje	120	1
<b>9492</b>	350	50	26	Hormigonera	120	1

**PP negro - PVC negro**

Código	Ø			Descripción	kg	
<b>9498</b>	360	60	16	Carretilla	130	1
<b>9499</b>	360	60	26	Hormigonera	130	1



**· Ruedas cespederas plásticas**

**Rueda reforzada - PP con banda de PVC**

Código	Ø				kg	
<b>19744</b>	125	31	10	33	50	1
<b>19781</b>	125	31	13	33	50	1
<b>19782</b>	152	33	13	33	70	1
<b>19783</b>	178	35	13	37	100	1
<b>19787</b>	178	35	19	37	100	1
<b>19792</b>	178	37	16	37	130	1
<b>19788</b>	200	37	19	37	130	1
<b>19784</b>	200	37	13	37	130	1
<b>19793</b>	200	37	16	37	130	1



**Rueda liviana - PP con banda de PVC**

Código	Ø				kg	
<b>9581</b>	110	28	10	28	15	40
<b>9582</b>	135	35	10	38	20	55
<b>9583</b>	160	43	10	45	25	45
<b>9586</b>	180	45	13	45	25	32



**Bicolor - Línea europea**

Código	Ø			-	kg	
<b>21611</b>	110	35	10	-	15	50
<b>21613</b>	130	40	10	-	20	50
<b>21615</b>	155	40	10	-	25	50
<b>21618</b>	180	46	13	-	25	36



**Rueda banda de goma**

Código	Ø				kg	
<b>19745</b>	125	33	13	31	50	40
<b>19746</b>	152	33	13	33	70	30
<b>19747</b>	178	37	13	35	100	30
<b>19748</b>	203	41	13	35	130	12





**· Ruedas de chapa y goma - con buje de Nylon**



**Rueda sola**

Código	∅	h			kg	
19488	125	32	13	38	80	10
19495	160	39	16	47	100	10
19496	175	43	16	47	120	10
19498	200	45	16	47	130	10
19499	250	57	16	47	130	10
19489	160	39	19	47	100	10
19490	175	43	19	47	120	10
19491	200	45	19	47	130	10
19492	250	57	19	47	130	10



**· Ruedas PP negro**

**PP negro con buje de Nylon**

Código	∅	h			kg	
19564	100	43	16	48	70	10
19563	100	43	19	48	70	6
19559	125	43	16	48	90	10
19560	125	43	19	48	90	6
19557	150	44	16	48	110	10
19558	150	44	19	48	110	6
19561	200	44	16	48	160	10
19562	200	44	19	48	160	6

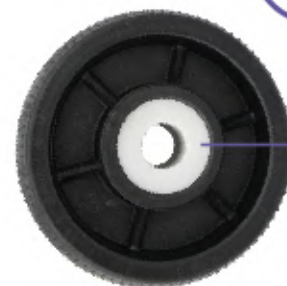

**· Ruedas para changuitos de compras**

**Ruedas varias**

Código	∅	h		Descripción	kg	
9588	160	25	8	Chango super - liviana	15	48
9589	160	35	8	Chango super - reforz.	25	50
22057	160	32	8	Con traba	20	100
22060	175	40	8	Kit x 2 c/ traba	30	1
9587	96	21	8	Soporte bicicleta	50	1



9588



9589



22057

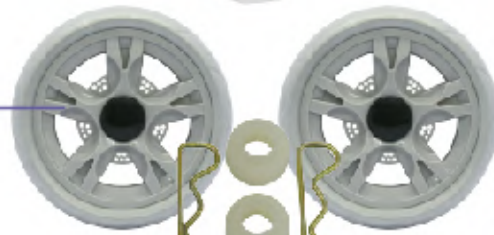

22060

\* El kit de ruedas 22060 incluye chavetas y bujes de Nylon



**· Ruedas cochecito para bebé**

**5 rayos goma eva**

Código	Ø			-	kg	
22062	160	36	8	-	15	169
22063	175	41	8	-	20	84
22064	200	41	8	-	20	70

**5 rayos dobles goma eva**

Código	Ø			-	kg	
22050	170	38	8	-	15	90
22055	180	41	8	-	20	84

**Diseño especial**

Código	Ø			Descripción	kg	
22052	195	42	8	3 rayos gris	20	1
22068	198	40	8	5 rayos cromada	20	1



**· Ruedas parapatines y roller**

**PU para roller**

Código	Ø			Dureza	Rulemán (no incluido)	Pack	
22110	70	22	24	78 A	608 - ZZ	Blister x 4 u.	60
22112	72	22	24	78 A	608 - ZZ	Blister x 4 u.	60
22116	76	22	24	78 A	608 - ZZ	Blister x 4 u.	60
22120	80	22	24	78 A	608 - ZZ	Blister x 4 u.	60
22130	70	22	24	82 A	608 - ZZ	Blister x 4 u.	60
22132	72	22	24	82 A	608 - ZZ	Blister x 4 u.	60
22136	76	22	24	82 A	608 - ZZ	Blister x 4 u.	60
22140	80	22	24	82 A	608 - ZZ	Blister x 4 u.	60

**PU para patines**

Código	Ø			Dureza	Rulemán	Pack	
22180	50	22	30	100 A	608 - ZZ	Blister x 4 u.	60
22182	52	22	30	100 A	608 - ZZ	Blister x 4 u.	60
22183	52	22	36	100 A	608 - ZZ	Blister x 4 u.	60
22186	54	22	36	100 A	608 - ZZ	Blister x 4 u.	60

**Rulemanes p/ patines y roller**

Código	Número	Modelo	Calidad	Pack	
22195	608	ZZ	ABCE 5	8 rulemanes + 4 bujes	60
22196	608	ZZ	ABCE 7	8 rulemanes + 4 bujes	60





**· Ruedas de acero para portón**

**Canal V - 1 rulemán**

Código					-	Rulemán	kg	
22204	38	15	8 x 50	24	-	608 - ZZ	40	40
22205	50	18	8 x 50	24	-	6200 - 2 RS	50	30
22206	63	18	8 x 50	24	-	6200 - 2 RS	70	28
22207	70	18	10 x 50	24	-	6201 - 2 RS	90	30
22208	82	18	10 x 50	24	-	6201 - 2 RS	130	15
22209	90	20	11 x 65	35	-	6202 - 2 RS	150	15
22210	100	20	13 x 60	35	-	6203 - 2 RS	170	12
22212	120	20	13 x 60	35	-	6203 - 2 RS	190	10

**Canal U - 1 rulemán**

Código						Rulemán	kg	
22220	38	15	8 x 50	24	7	608 - ZZ	40	40
22221	50	18	8 x 50	24	7.5	6200 - 2 RS	50	30
22222	63	18	8 x 50	24	7.5	6200 - 2 RS	70	28
22223	70	18	10 x 50	24	9	6201 - 2 RS	90	30
22224	82	18	10 x 50	24	9	6201 - 2 RS	130	15
22225	90	20	11 x 65	35	9	6202 - 2 RS	150	15
22226	100	20	13 x 60	35	9	6203 - 2 RS	170	12
22227	120	20	13 x 60	35	10.5	6203 - 2 RS	190	10

**Canal V - 2 rulemanes**

Código					-	Rulemán	kg	
22240	100	30	14 x 70	44	-	6203 - 2 RS	300	8
22242	120	30	14 x 70	44	-	6203 - 2 RS	350	6
22244	140	30	13 x 77	42	-	6203 - 2 RS	400	4

**Canal U - 2 rulemanes**

Código						Rulemán	kg	
22251	100	30	14 x 70	44	13.5	6203 - 2 RS	300	8
22253	120	30	14 x 70	44	13.5	6203 - 2 RS	350	6
22255	140	30	14 x 70	44	13.5	6203 - 2 RS	400	4

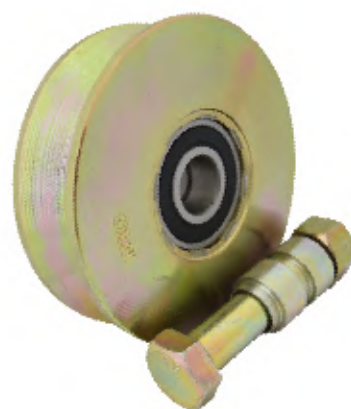
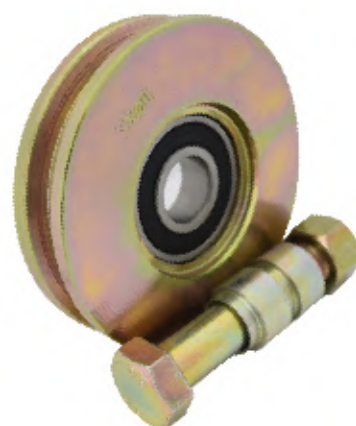
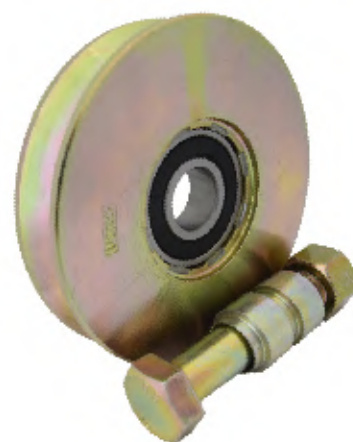

\* Todas las ruedas de acero para portón vienen en un packaging individual que incluye bulón de acero, tuerca y bujes.





**· Ruedas de acero para portón**

**Lisa - 1 rulemán**

Código					Rulemán	kg	
22230	50	18	8 x 50	24	6200 - 2 RS	50	30
22231	60	18	8 x 50	24	6200 - 2 RS	70	28
22232	70	18	10 x 50	24	6201 - 2 RS	90	30
22233	80	18	10 x 50	24	6201 - 2 RS	130	15



**Canal V - 1 rulemán, con soporte**

Código						Rulemán	kg	
22256	50	18	25	96°	6200 - 2 RS	50	30	
22257	60	18	25	96°	6200 - 2 RS	70	30	
22261	80	20	30	96°	6203 - 2 RS	120	20	
22262	90	20	30	96°	6203 - 2 RS	150	20	
22263	100	20	30	96°	6203 - 2 RS	170	10	



**Canal U - 1 rulemán, con soporte**

Código					Rulemán	kg	
22267	80	20	30	9	6203 - 2 RS	120	20
22268	90	20	30	10.5	6203 - 2 RS	150	20
22269	100	20	30	10.5	6203 - 2 RS	170	15



**· Estabilizadores y rodillos de Nylon para portón**

**Estabilizadores para portones**

Código	L min-max	H	A min-max	B	Descripción	Bulón	
22292	140	143	35/70	60	2 rodillos	14mm	10
22294	130/140	222	35/53	55	4 rodillos	14mm	10

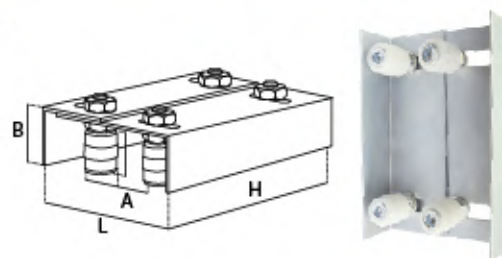

**Rodillos de Nylon para estabilizadores**

Código	D	X	L	-	-	Bulón	
22296	32	40	73	-	-	14mm	60
22298	40	40	73	-	-	14mm	40

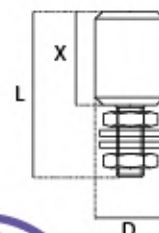

\* Bulones de 14 mm  
\* Espesor chapa 3 mm



**Estabilizadores regulables**







**· Ruedas de Nylon para portón**

**Canal V - 1 rulemán**

Código					-	Rulemán	kg	
22275	50	18	5/16"	23	-	6200 - 2 RS	50	30
22276	60	18	5/16"	23	-	6200 - 2 RS	70	28
22277	70	18	5/16"	23	-	6200 - 2 RS	90	30
22278	80	20	5/16"	35	-	6200 - 2 RS	110	15
22279	90	20	7/16"	35	-	6202 - 2 RS	140	15
22280	105	20	1/2"	35	-	6203 - 2 RS	160	12
22281	120	20	1/2"	35	-	6203 - 2 RS	180	10

**Canal U - 1 rulemán**

Código						Rulemán	kg	
22285	50	18	5/16"	23	7	6200 - 2 RS	50	30
22286	60	18	5/16"	23	7	6200 - 2 RS	70	28
22287	70	18	5/16"	23	9	6200 - 2 RS	90	30
22288	80	20	5/16"	35	9	6200 - 2 RS	110	15
22289	90	20	7/16"	35	9	6202 - 2 RS	140	15
22290	105	20	1/2"	35	9	6203 - 2 RS	160	12
22291	120	20	1/2"	35	10.5	6203 - 2 RS	180	10

**Canal V - 2 rulemanes**

Código					-	Rulemán	kg	
22247	105	29	1/2"	44	-	6203 - 2 RS	260	8
22248	120	29	1/2"	44	-	6203 - 2 RS	320	6

**Canal U - 2 rulemanes**

Código						Rulemán	kg	
22258	105	29	1/2"	44	13.5	6203 - 2 RS	260	8
22259	120	29	1/2"	44	13.5	6203 - 2 RS	320	6

**Bujes de Nylon - soporte p/ rulemanes**

Código				Bulón	Rulemán	kg	
	A- ømm	B- ømm	C- ømm				
60953	14.3	9.8	8	8mm	6200 - 2 RS	-	20
60955	17.5	11.8	10	9.5mm	6201 - 2 RS	-	20
60957	19.2	14.8	11.3	11mm	6202 - 2 RS	-	20
60959	22.2	16	13	12mm	6203 - 2 RS	-	20
60960	23	19	13	12mm	6203 - 2 RS	-	20



\* Todas las ruedas de Nylon para portón vienen en un packaging individual que incluye bulón de acero, tuerca y bujes de Nylon





**· Ruedas neumáticas - llanta PP gris**

**4.00 - 8" - 2 telas (30 lbs)**

Código	Ø			Descripción	kg	Telas	
23210	390	90	17	Eje carretilla	90	2	5
23211	390	90	19	Buje Nylon	90	2	5
23214	390	90	26	Buje Nylon	90	2	5

*\*Estos modelos utilizan: Cámaras pico recto 9563 y cubiertas 9573.*



**4.00 - 8" - 4 telas (35 lbs)**

Código	Ø			Descripción	kg	Telas	
23215	390	90	17	Eje carretilla	120	4	5
23218	390	90	19	Buje Nylon	120	4	5
23219	390	90	26	Buje Nylon	120	4	5
23221	390	90	25	Rulemán 6205 - ZZ	120	4	5
23223	390	90	25.7	Rulemán especial SAE	120	4	5
23224	390	90	19.2	Rulemán especial SAE	120	4	5

*\*Estos modelos utilizan: Cámaras pico recto 9563 y cubiertas 9575.*



**4.00 - 8" - 6 telas (40 lbs)**

Código	Ø			Descripción	kg	Telas	
23225	390	90	26	Buje Nylon	200	6	4
23226	390	90	17	Eje carretilla	200	6	4
23227	390	90	25.7	Rulemán especial SAE	200	6	4
23228	390	90	25	Rulemán 6205 - ZZ	200	6	4

*\*Estos modelos utilizan: Cámaras pico recto 9563 y cubiertas 19545.*



**oxen MAX**

**3.50 - 8" - 2 telas (30 lbs)**

Código	Ø			Descripción	kg	Telas	
23161	375	80	17	Eje carretilla	85	2	5
23162	375	80	19	Buje Nylon	85	2	5
23163	375	80	26	Buje Nylon	85	2	5

*\*Estos modelos utilizan: Cámaras pico recto 9569 y cubiertas 19539.*



**3.50 - 8" - 4 telas (35 lbs)**

Código	Ø			Descripción	kg	Telas	
23165	375	80	17	Eje carretilla	110	4	5
23168	375	80	19	Buje Nylon	110	4	5
23169	375	80	26	Buje Nylon	110	4	5

*\*Estos modelos utilizan: Cámaras pico recto 9569 y cubiertas 9574.*





**• Ruedas neumáticas - llanta PP gris**

**3.50 - 8" - 6 telas (40 lbs)**

Código	Ø	↑	⊙	Descripción	kg	Telas	📦
23171	375	80	19	Buje Nylon	180	6	5
23172	375	80	26	Buje Nylon	180	6	5
23173	375	80	17	Eje carretilla	180	6	5
23174	375	80	19.2	Rulemán especial SAE	180	6	5
23175	375	80	25.7	Rulemán especial SAE	180	6	5

\*Estos modelos utilizan: Cámaras pico recto 9569 y cubiertas 19548.

**3.00 - 8" - 2 telas (30 lbs)**

Código	Ø	↑	⊙	Descripción	kg	Telas	📦
23201	350	70	17	Eje carretilla	80	2	6
23202	350	70	19	Buje Nylon	80	2	6
23205	350	70	26	Buje Nylon	80	2	6
23206	350	70	16	Buje Nylon	80	2	6

\*Estos modelos utilizan: Cámaras pico recto 9562 y cubiertas 9572.

**3.50 - 4" con buje de Nylon - 2 telas (30 lbs)**

Código	Ø	↑	⊙	Descripción	kg	Telas	📦
23101	250	80	16	Eje desplazado	80	2	10
23102	250	80	19	Eje desplazado	80	2	10
23103	250	80	16	Eje centrado	80	2	10
23104	250	80	19	Eje centrado	80	2	10

\*Estos modelos utilizan: Cámaras pico curvo 9560 y cubiertas 9571.

**3.50 - 4" con rulemán - 2 telas (30 lbs)**

Código	Ø	↑	⊙	Descripción	kg	Telas	📦
23105	250	80	16	Eje desplazado	90	2	10
23106	250	80	19	Eje desplazado	90	2	10
23107	250	80	16	Eje centrado	90	2	10
23108	250	80	19	Eje centrado	90	2	10

\*Estos modelos utilizan: Cámaras pico curvo 9560 y cubiertas 9571.

**3.50 - 4" con buje de Nylon - 4 telas (35 lbs)**

Código	Ø	↑	⊙	Descripción	kg	Telas	📦
23111	250	80	16	Eje desplazado	90	4	10
23112	250	80	19	Eje desplazado	90	4	10
23113	250	80	16	Eje centrado	90	4	10
23114	250	80	19	Eje centrado	90	4	10

\*Estos modelos utilizan: Cámaras pico curvo 9560 y cubiertas 19540.



oxen MAX





**• Ruedas neumáticas - llanta PP gris**

**3.50-4" con rulemán - 4 telas (35 lbs)**

Código	Ø	mm	mm	Descripción	kg	Telas	Box
23115	250	80	16	Eje desplazado	100	4	10
23116	250	80	19.2	Eje desplazado	100	4	10
23117	250	80	16	Eje centrado	100	4	10
23118	250	80	19.2	Eje centrado	100	4	10

\*Estos modelos utilizan: Cámaras pico curvo 9560 y cubiertas 19540.

**3.50-4" con buje de Nylon - 6 telas (40 lbs)**

Código	Ø	mm	mm	Descripción	kg	Telas	Box
23122	250	80	16	Eje desplazado	130	6	10
23124	250	80	19	Eje desplazado	130	6	10
23126	250	80	16	Eje centrado	130	6	10
23128	250	80	19	Eje centrado	130	6	10

\*Estos modelos utilizan: Cámaras pico curvo 9560 y cubiertas 19546.

**3.50-4" con rulemán - 6 telas (40 lbs)**

Código	Ø	mm	mm	Descripción	kg	Telas	Box
23123	250	80	16	Eje desplazado	130	6	10
23127	250	80	16	Eje centrado	130	6	10
23125	250	80	19.2	Eje desplazado	130	6	10
23129	250	80	19.2	Eje centrado	130	6	10

\*Estos modelos utilizan: Cámaras pico curvo 9560 y cubiertas 19546.

**2.50-4" con buje de Nylon - 2 telas (30 lbs)**

Código	Ø	mm	mm	Descripción	kg	Telas	Box
23091	220	68	16	Eje desplazado	70	2	10
23092	220	68	19	Eje desplazado	70	2	10
23093	220	68	16	Eje centrado	70	2	10
23094	220	68	19	Eje centrado	70	2	10

\*Estos modelos utilizan: Cámaras 2.50-4" pico curvo 9559 y cubiertas 2.50-4" 9570.

**2.50-4" con rulemán - 2 telas (30 lbs)**

Código	Ø	mm	mm	Descripción	kg	Telas	Box
23095	220	68	16	Eje desplazado	80	2	10
23097	220	68	16	Eje centrado	80	2	10

\*Estos modelos utilizan: Cámaras 2.50-4" pico curvo 9559 y cubiertas 2.50-4" 9570.



oxen MAX



oxen MAX





**• Ruedas semineumáticas PU - llanta PP gris**

**3.50-4" - Eje centrado**

Código	Ø			Descripción	kg	
23030	250	80	16	Buje Nylon	100	10
23031	250	80	19	Buje Nylon	100	10
23035	250	80	16	Rulemán	100	10
23036	250	80	19	Rulemán	100	10



oxen MAX

**3.50-4" - Eje desplazado**

Código	Ø			Descripción	kg	
23022	250	80	16	Buje Nylon	100	10
23023	250	80	19	Buje Nylon	100	10
23027	250	80	16	Rulemán	100	10
23028	250	80	19	Rulemán	100	10



oxen MAX

**• Ruedas semineumáticas PU - llanta PP negra**

**3.50-4" - Eje centrado**

Código	Ø			Descripción	kg	
23058	250	80	16	Buje Nylon	100	10
23059	250	80	19	Buje Nylon	100	10
23062	250	80	16	Rulemán	100	10
23063	250	80	19	Rulemán	100	10



oxen MAX

**3.50-4" - Eje desplazado**

Código	Ø			Descripción	kg	
23051	250	80	16	Buje Nylon	100	10
23052	250	80	19	Buje Nylon	100	10
23054	250	80	16	Rulemán	100	10
23055	250	80	19	Rulemán	100	10



oxen MAX

**• Ruedas semineumáticas PU - llanta PP gris**

**3.50-8"**

Código	Ø			Descripción	kg	
23041	375	80	19	Buje Nylon	120	6
23042	375	80	26	Buje Nylon	120	6
23043	375	80	17	Eje Carretilla	120	6



oxen MAX



**• Ruedas para sillas de ruedas - con rulemán 608 zz**

**Rueda para silla de ruedas**

Código	∅			Descripción	kg	Telas	
23150	200	52	8	Neumática	80	2	10
23152	200	28	8	Maciza eje desplaz.	80	-	16
23153	200	28	8	Maciza eje centrado	80	-	16

*\*El modelo 23150 utiliza: Cámara 200x50mm - pico curvo 9558  
Cubierta 200x50mm 9556 / dibujo rayado.*



• Eje desplazado para usar sin horquilla



• Eje centrado para usar con horquilla



**• Ruedas neumáticas - llanta de chapa**

**Con horquilla - base giratoria**

Código	∅			Descripción	kg	Telas	
9524	200	55	110 x 115	Cubierta 2.50 - 4" (9570)	70	2	4
9526	250	80	110 x 115	Cubierta 3.50 - 4" (9571)	80	2	4
9611	325	80	110 x 115	Cubierta 4.00 - 6" (19541)	100	2	1

**Con horquilla - base fija**

Código	∅			Descripción	kg	Telas	
9523	220	55	110 x 115	Cubierta 2.50 - 4" (9570)	70	2	4
9525	250	80	110 x 115	Cubierta 3.50 - 4" (9571)	80	2	4

**Llanta chapa - eje desplazado**

Código	∅			Descripción	kg	Telas	
9508	250	80	16	Cubierta 3.50 - 4"	80	2	10
9507	250	80	19	Cubierta 3.50 - 4"	80	2	10





## ·Cubiertas y cámaras

## Cubiertas ruedas 2 telas

Código	Ø	Descripción	Telas	
9556	200	200x50	2	10
9570	220	2.50 - 4"	2	10
9571	250	3.50 - 4"	2	10
19541	325	13" x 4.00 - 6"	2	10
9572	350	3.00 - 8"	2	10
19539	375	3.50 - 8"	2	10
9573	390	4.00 - 8"	2	10



## Cubiertas ruedas 4 telas

Código	Ø	Descripción	Telas	
19540	250	4.10/3.50 - 4" Cuadrada	4	10
9574	375	3.50 - 8"	4	10
9575	390	4.80/4.00 - 8" Cuadrada	4	10



## Cubiertas ruedas 6 telas

Código	Ø	Descripción	Telas	
19546	265	3.50 - 4"	6	10
19548	375	3.50 - 8"	6	10
19545	390	4.00 - 8"	6	10

OXEN MAX



## Cámaras

Código	Ø	Descripción	-	
9558	200	200 x 50 Pico curvo	-	20
9559	220	2.50 - 4" Pico curvo	-	20
9560	250	3.50 - 4" Pico curvo	-	20
9561	250	3.50 - 4" Pico recto	-	20
9562	350	3.00 - 8" Pico recto	-	20
9569	375	3.50 - 8" Pico recto	-	20
9563	400	4.00 - 8" Pico recto	-	20

OXEN MAX



**Bujes y rulemanes para ruedas****Bujes de acero**

Código		Largo	Fracción
896	8	29	10 u.
897	8	24	10 u.
901	9.5	27	10 u.
900	11.5	34	10 u.
903	12	40	10 u.
898	12.7	37	10 u.
899	12.7	45	10 u.
908	15	45	10 u.
910	17	50	10 u.
911	17	62	10 u.
912	19	50	10 u.
913	19	62	10 u.
915	20	62	10 u.
916	20	56	10 u.

**Bujes PP**

Código				-	Fracción	
19341	35	19	14	37	-	10 u.
19342	35	20	14	37	-	10 u.
22460	52	17	67	52	Carretilla	10 u.



Carretilla

**Bujes de Nylon blanco para ruedas**

Código				-	Fracción	
19343	35	16	5	11	-	10 u.
19344	35	19	5	11	-	10 u.
22441	40	19	5	12	-	10 u.
22442	40	16	5	12	-	10 u.
22453	52	16	4	14	-	10 u.
22452	52	19	4	14	-	10 u.
22451	52	26	4	14	-	10 u.

**Rulemanes especiales**

Código				Número	Modelo	Calidad	Fracción
22404	30	10	9	6200	2RS	Estándar	10 u.
22405	32	12.7	10	6201	2RS	Especial	10 u.
22409	35	16	11	6202	2RS	Especial	10 u.
22408	35	19.2	11	6202	2RS	Estándar	10 u.
22415	47	19.2	14	6204	ZZ	Especial	10 u.







· Horquillas de acero galvanizado

Soldada giratoria 5 mm

Código	Ø						kg	
19908	100	50	106	115 x 100	10 x 20	5	300	20
19909	125	50	115	115 x 100	10 x 20	5	350	16
19910	150	50	153	115 x 100	10 x 20	5	400	12
19911	200	50	140	115 x 100	10 x 20	5	450	8



Soldada fija 5 mm

Código	Ø						kg	
19901	100	50	106	115 x 100	10 x 20	5	300	20
19902	125	50	115	115 x 100	10 x 20	5	350	16
19903	150	50	153	115 x 100	10 x 20	5	400	12
19904	200	50	140	115 x 100	10 x 20	5	450	8



Estampada giratoria para changos

Código	Ø				-		kg	
19673	100	29	80	13	-	2.5	120	40
19674	125	29	90	13	-	2.5	140	40



Estampada giratoria

Código	Ø						kg	
19890	80	40	71	100 x 80	9 x 13	2.5	150	40
19891	100	40	78	100 x 80	9 x 13	2.5	170	40
19892	125	48	89	100 x 80	9 x 13	2.5	200	40
19893	150	48	99	100 x 80	9 x 13	2.5	220	30
19894	160	60	112	131 x 104	11 x 16	2.5	220	20



Estampada giratoria

Código	Ø						kg	
19895	100	32	85	128 x 101	10 x 11 Giratoria	3	150	-





## · Apiladores manuales

## Apiladores manuales

Código	Descripción	Peso del apilador
17050	Apilador 1 Tn	200 kg

- Velocidad controlable de bajada
- Capacidad de elevación: 1000 kg
- Altura máxima: 1,60 m
- Torre simple
- Altura del apilador: 2,04 m
- Altura mínima de horquillas: 90 mm
- Largo de horquillas: 1,15 m
- Horq. ajust.: de 320 mm hasta 680 mm
- Ancho exterior de patas: 690 mm
- Rodillos delanteros: 74 x 52 mm
- Rueda trasera: 180 x 50 mm



Código	Descripción	Peso del apilador
17061	Apilador 1.5 Tn	295 kg

- Velocidad controlable de bajada
- Capacidad de elevación: 1500 kg
- Altura máxima: 2 m
- Torre doble
- Altura del apilador: 1,55 m
- Altura mínima de horquillas: 90 mm
- Largo de horquillas: 1,15 m
- Horq. ajust.: de 320 mm hasta 680 mm
- Ancho exterior de patas: 690 mm
- Rodillos delanteros: 74 x 52 mm
- Rueda trasera: 180 x 50 mm





• Transpallets

Transpallets

Código	Descripción	Base
17003	Transpallets pintado	1150 x 550 mm
17004	Transp. ancho pintado	1220 x 680 mm
17010	Kit de repuestos - conj. oring y retenes zorra 3 Tn	

- Capacidad de carga: 3000 kg
- Rueda volante: 19502 - Rueda fundición y PU (2 rulemanes de 180 x 50 mm).
- Rodillo delantero: 19504 - Rodillo PU 80 x 70 mm (4 unidades).
- Altura de uña: 85 mm
- Altura de elevación: 195 mm

17008	Transp. ancho galvanizado	1220 x 680 mm
-------	---------------------------	---------------

- Capacidad de carga: 2500 kg
- Rueda volante: Rueda de nylon
- Rodillo delantero: Rodillo nylon (4 u).
- Altura de uña: 85 mm
- Altura de elevación: 195 mm
- Base de 1220 x 680 mm

17005	Transp. acero inoxidable	1150 x 550 mm
-------	--------------------------	---------------

- Capacidad de carga: 3000 kg
- Rueda volante: Rueda Nylon (2 rulemanes de 180 x 50 mm).
- Rodillo delantero: 19528 - Rodillo Nylon 80 x 70 mm (4 unidades).
- Rueda delantera: Rueda plástica 50 x 29 mm (2 unidades).
- Altura de uña: 85 mm
- Altura de elevación: 195 mm

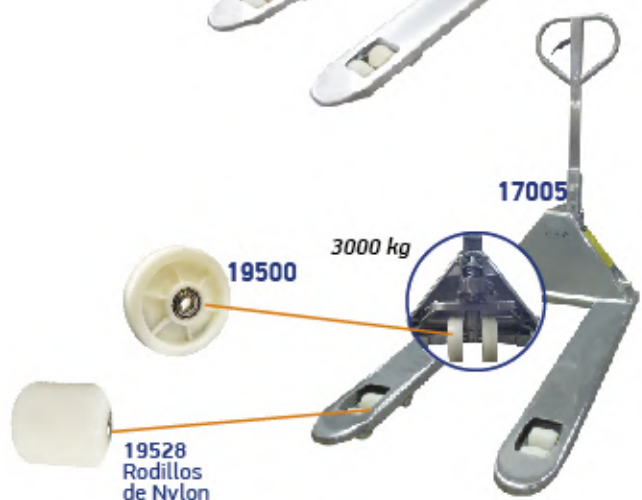

• Carros paqueteros - plataformas

Plataformas base plástica

Código	Descripción
19213	Plataforma plegable
	<ul style="list-style-type: none"> <li>• Capacidad de carga: 150 kg</li> <li>• Plataforma: Plástica 720 x 480 mm</li> <li>• Altura total: 850 mm</li> <li>• Rueda 100 mm giratoria 19607 - Rueda 100 mm fija 19602</li> </ul>
19215	Plataforma plegable
	<ul style="list-style-type: none"> <li>• Capacidad de carga: 300 kg</li> <li>• Plataforma: Plástica 880 x 580 mm</li> <li>• Altura total: 880 mm</li> <li>• Rueda 125 mm giratoria 19608 - Rueda 125 mm fija 19603</li> </ul>





• Carros paqueteros 2 ruedas

Carros para 100 kg

Código	Descripción
19211	Pintura epoxi - Rueda maciza
19212	Pintura epoxi - Rueda neum. 220 mm

- Capacidad de carga: 100 kg
- Plataforma: 250 x 350 x 2.85 mm
- Eje macizo de 16 mm
- Caño de 25.4 mm / Pared de 1.25 mm
- Espalda recta
- Pintura epoxi

19561



PP negro con buje de Nylon (16 mm).

23091



Neumática 220 mm eje desplazado (16 mm).



Carros para 150 kg

Código	Descripción
19217	Espalda curva - Rueda neumática
19218	Espalda curva - Rueda maciza
19226	Espalda curva - Rueda neum. de chapa

- Capacidad de carga: 150 kg
- Plataforma: 250 x 350 x 3.20 mm
- Eje macizo de 16 mm
- Caño de 25.4 mm / Pared de 1.25 mm
- 2 Ruedas de 250 mm
- Pintura epoxi

23101



2 telas con buje de Nylon (16 mm).

22365



Goma - PP gris 250 mm con buje Nylon (16 mm).

9508



2 telas - 250 mm eje desplazado.



Carros para 200 kg

Código	Descripción
19219	Espalda curva - Rueda maciza 250 mm
19220	Espalda curva - Rueda neumática 325 mm
19222	Espalda curva - Rueda neum. 250 mm - 4 telas

- Capacidad de carga: 200 kg
- Plataforma: 300 x 350 x 3.20 mm
- Eje macizo de 16 mm
- Caño de 31.7 mm / Pared de 1.6 mm
- Pintura epoxi

23111



4 telas con buje de Nylon (16 mm).

22365



Goma - PP gris 250 mm con buje Nylon (16 mm).



**• Carritos plegables****Carritos plegables con bolsa**

Código	Ø Rueda	Descripción	kg
19300	165	Carro con bolso - 2 ruedas	30
19302	175	Carro con bolso - 2 ruedas grises	40
22057	165	Rueda p/carro compras c/ traba std	20
22060	175	Ruedas kit x 2 carrito para compras	30

**\*Reforzados**  
**\*Tela poliéster de PVC**  
**super resistente**

**Carritos plegables**

Código	Ø Rueda	Descripción	kg
19198	100	Carrito plegable chico	40
19199	140	Carrito plegable grande	60

• **Identificador de color por modelo (medidas):** ■ 19198

■ 19199



Con amarre elástico



\*Pintura esmaltada en horno

**Carritos plegables**

Código	Ø Rueda	Descripción	kg
19200	125	Rueda TPR azul 125 mm	40
19209	130	Carro alum. plegable - base chapa 2 ruedas	70
19210	130	Carro alum. plegable - base alum. 2 ruedas	70
19227	150	Carro acero plegable - base acero 2 ruedas	70

**• Carretilla batea plástica****Carretilla**

Código	Descripción
21914	Carretilla plástica

- Capacidad de carga: 85 L
- Batea: Plástica
- Tipo de rueda: Rueda neumática llanta de chapa pintada 350 mm
- Chasis: Caño galvanizado



23214  
Rueda repuesto



*dejamos nuestra huella*



RUEDAS OXEN RUEDAS OXEN RUEDAS OXEN RUEDAS OXEN RUEDAS OXEN RUEDAS OXEN RUEDAS OXEN RUEDAS OXEN RUEDAS OXEN RUEDAS OXEN RUEDAS OXEN RUEDAS OXEN RUEDAS OXEN RUEDAS OXEN

Nuestro compromiso es garantizar  
la calidad que nos caracteriza en el mercado  
de ruedas; el crecimiento continuo nos permite  
ofrecer y desarrollar productos de excelencia,  
respondiendo a las necesidades específicas  
de nuestros clientes.



ESCANEAR  
PARA ACCEDER  
AL CATÁLOGO  
DIGITAL

